



MMA Roundline Cylinders

*ISO 6022 cylinders for
working pressures up to 250 bar*

*Catalogue HY07-1210/UK
October 2002*



Note: In line with our policy of continuing product improvement, specifications in this catalogue are subject to change without notice.

Contents	Page	Index	Page
Introduction	3	Accessories	13
inPHorm	3	Air Bleeds	6
Design Features and Benefits	4	Cushioning	4, 17, 18, 21
Gland and Piston Seal Options	5	Design Features	4
Optional Features	6	Filtration	19
Special Designs	6	Forces – Push and Pull	14
Mounting Information	7	Gland Drains	6
Cylinder Masses	7	inPHorm	3
Servicing Features	7	Long Stroke Cylinders	15
Cylinder Selection Checklist	8	Masses	7
Mounting Styles	9	Model Numbers	25
Round Flange Mountings	10	Mounting Styles and Information	9, 10-13
Clevis Mountings	11	Optional Features	6
Trunnion and Foot Mountings	12	Ordering Instructions	25
Rod End Accessories	13	Piston Rod End Data	24
Push and Pull Forces	14	Piston Rod Size Selection	15
Piston Rod Size Selection	15	Piston Speeds	21
Long Stroke Cylinders	15	Piston and Seal Types	5, 19
Stop Tubes	15, 16	Ports – Standard and Oversize	20, 21
Stroke Factors	16	Port Size and Piston Speed	21
Cushioning	17, 18	Repairs	7
Seals and Fluids	19	Replacement Parts and Service	22-23
Ports	20	Seals and Fluids	19
Ports, Locations and Piston Speeds	21	Special Designs	6
Replacement Parts and Service	22	Standard Specifications	3
Piston Rod End Data	24	Stop Tubes	15, 16
How to Order Cylinders	25	Stroke Factors	16

Introduction

Parker Hannifin Corporation is a world leader in the manufacture of components and systems for motion control. Parker has more than 800 product lines for hydraulic, pneumatic and electromechanical applications in some 1200 industrial, mobile and aerospace markets. With more than 45,000 employees and some 210 manufacturing plants and administration offices around the world, Parker provides customers with technical excellence and first class customer service.

Parker Hannifin's Cylinder Division is the world's largest supplier of hydraulic cylinders for industrial applications. Parker cylinders are used in applications as diverse as machine tools, flight simulation and tidal barrier control.

The heavy duty Series MMA cylinder has been designed for service in steel mills and in other arduous applications where a rugged, dependable cylinder is required. In addition to the

standard cylinders featured in this catalogue, MMA cylinders can be designed and manufactured to suit individual customer requirements. Our engineers will be pleased to discuss and advise on unique designs to suit specific applications.

inPHorm

inPHorm is Parker Hannifin's product selection program that helps to select the correct part for an application. The program prompts for the details of the application, makes the necessary design calculations, and selects a suitable product. inPHorm can also generate CAD drawings of the selected part, which can be viewed in other software applications, and customised and imported into other CAD packages. Please contact your local Sales Office for further information.

Standard Specifications

- Heavy Duty construction
- Styles and dimensions to: CETOP RP73H, ISO 6022*, DIN 24 333, BS 6331 Pt. III, AFNOR NF E48-025, VW 39D 921
- Rated pressure: 250 bar
- Fatigue-free at the rated pressure
- Hydraulic mineral oil – other fluids on request
- Temperature range of standard seals: -20°C to +80°C
- Construction: head & cap bolted to heavy steel flanges
- Bore sizes: 50mm to 320mm
- Piston rod diameters: 32mm to 220mm
- Cushioning – optional both ends
- Air bleeds – optional both ends
- Tested in accordance with ISO 10100:2001

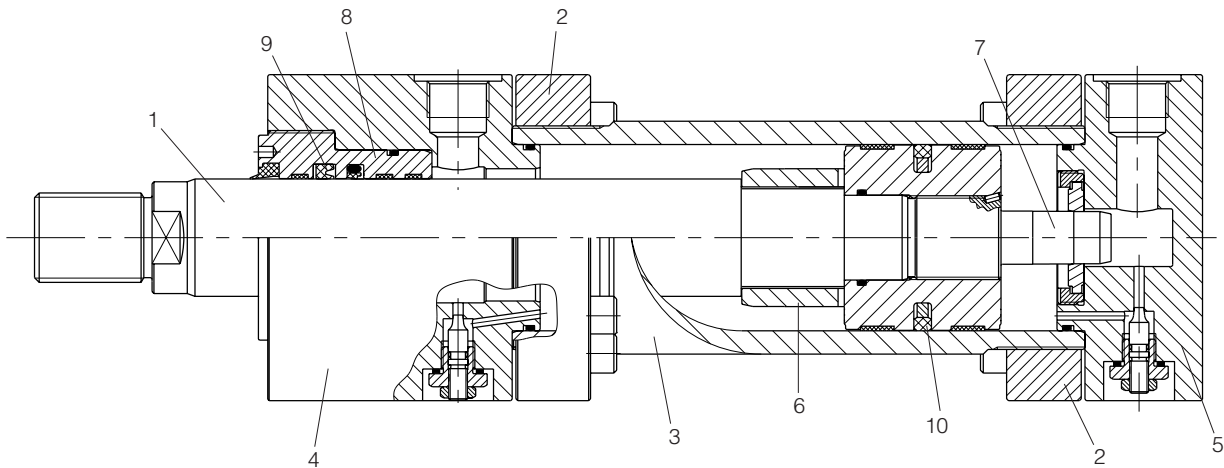

1 Piston Rod

Manufactured from precision ground, high tensile carbon alloy steel, hard chrome plated and polished to 0.2µm max. Piston rods up to 110mm in diameter are induction case hardened to Rockwell C54 minimum before chrome plating. This provides a 'dent resistant' surface, resulting in improved seal life. Piston rods of 125mm diameter and above can be case hardened on request. All rod and piston assemblies are designed to be fatigue free at full rated pressure.

2 Head and Cap Retention

The head and cap are bolted to heavy steel flanges, which are retained by threads at each end of the cylinder body.

3 Cylinder Body

The heavy wall steel tubing is honed to a high surface finish, to minimise internal friction and prolong seal life.

4 & 5 Head & Cap Ends

These are machined from steel and located into the cylinder body's internal diameter for added strength and precise alignment. Both the head and cap are sealed by O-rings which, in turn, are protected by anti-extrusion rings.

6 & 7 Cushioning

Optional cushions at the head and cap are progressive in action, providing controlled deceleration which reduces noise and shock loading, and prolongs machine life. The head end cushion is a self-centring sleeve, while the polished cap end spear is an integral part of the piston rod. Needle valves are provided at both ends of the cylinder for precise cushion adjustment, and are retained so that they cannot be inadvertently removed.

Check valves at the head and cap ends of the cylinder minimize restriction to the start of a stroke, permitting full power and fast cycle times. The head end check valve is incorporated into the fully floating cushion sleeve, while the cap end employs a floating bronze cushion bush.

8 Rod Gland and Bearings

Seals are housed in a corrosion-resistant steel gland, featuring heavy duty polymer bearing rings to resist side loadings. Wide separation of these rings reduces bearing stresses, maximising the service life of the bearing. The rod gland may be screwed or bolted. On bore sizes up to 100mm the rod gland is screwed (illustrated above). On larger bore sizes the rod gland is bolted.

The polymer bearing rings, with the rod seals, are easily replaced on removal of the rod gland, and all components may be serviced without further disassembly of the cylinder.

9 & 10 Gland and Piston Seals

A variety of gland and piston seal options is available, to suit different applications, as shown opposite. In addition, MMA cylinders can be designed and manufactured to suit individual customer requirements. Please contact the factory for details.

The gland seals listed opposite are located in a screwed or bolted gland housing, and provide efficient retention of pressurized fluid while preventing the ingress of contaminants.

Gland and Piston Seal Options

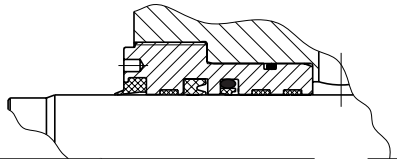
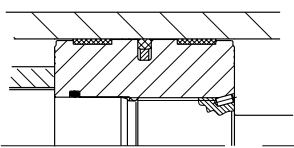
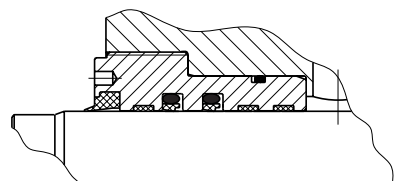
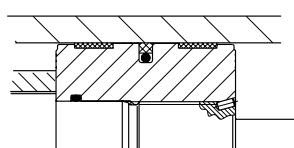
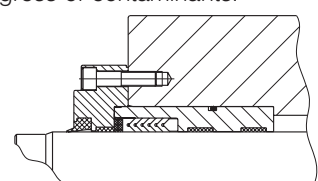
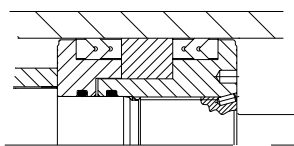
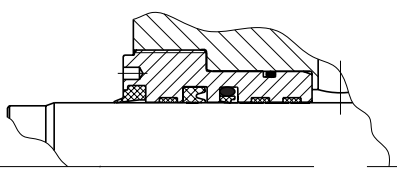
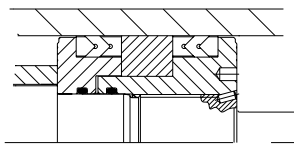
Application Information	Glands	Pistons
<p>Standard Option General purpose seals suitable for a wide range of applications.</p> <p>For use with Group 1 fluids (see page 19).</p> <p>The standard option may be used for piston speeds up to 0.5m/s.</p> <p>Ordering code 'N'</p>	<p>Standard gland seals consist of a combination of a polyurethane lipseal and a PTFE stepped seal, providing efficient sealing under normal operating conditions.</p> 	<p>Standard pistons consist of a heavy duty filled polymer seal, which is leaktight under normal operating conditions. Heavy duty wear rings prevent metal contact with the cylinder bore and help to protect the piston seal from contaminants.</p> 
<p>Low Friction Option Suitable for applications where very low friction and an absence of stick-slip are important. Not suitable for holding loads in a fixed position.</p> <p>For use with all fluid groups (see page 19).</p> <p>The Low Friction option may be used for piston speeds up to 1m/s.</p> <p>Ordering code 'F'</p>	<p>Low Friction gland seals comprise two low friction PTFE stepped seals and a heavy duty wiperseal.</p> 	<p>Low Friction pistons employ a PTFE seal and PTFE wear rings.</p> 
<p>Chevron Option Suitable for arduous applications, such as steel mills. May be used to hold a load in position.</p> <p>For use with all fluid groups (see page 19).</p> <p>The chevron option may be used for piston speeds up to 0.5m/s.</p> <p>Ordering code 'LL'</p>	<p>Chevron gland seals have a corrosion-resistant steel retainer, and a separate removable steel housing which retains the inner bearing rings. A heavy duty wiper seal prevents the ingress of contaminants.</p> 	<p>Chevron pistons feature a two-piece piston with a wide bearing ring mounted between chevron seals.</p> 
<p>Load Holding Option Suitable for applications where loads are required to be held in position. Standard gland seals have a lower friction than the chevron equivalent.</p> <p>For use with Group 1 fluids (see page 19).</p> <p>The load holding option may be used for piston speeds up to 0.5m/s.</p> <p>Ordering code 'A'</p>	<p>Standard gland seals consist of a combination of a polyurethane lipseal and a PTFE stepped seal, providing efficient sealing under normal operating conditions.</p> 	<p>Chevron pistons feature a two-piece piston with a wide bearing ring mounted between chevron seals.</p> 

Air Bleeds

Available as an option at both ends, air bleeds are recessed into the head and cap and retained so they cannot be inadvertently removed.

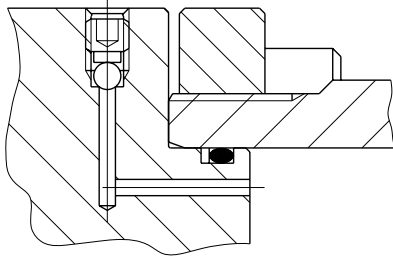
**Gland Drains**

The tendency of hydraulic fluid to adhere to the piston rod can result in an accumulation of fluid in the cavity between the seals under certain operating conditions. This may occur with long stroke cylinders, where there is a constant back pressure as in differential circuitry, or where the ratio of the extend speed to the retract speed is greater than 2 to 1.

Gland drains should be piped back to the fluid reservoir, which should be located below the level of the cylinder.

Standard and Low Friction glands can be fitted with gland drains. Please consult the factory for further information.

Position Feedback

Linear position transducers of various types may be fitted to MMA series cylinders. Please contact the factory for further details.

Position Switches

Non-contacting position switches are available for MMA series cylinders. Please contact the factory for further details.

Double Rodded Cylinders

MMA series cylinders are available with the option of a double-ended piston rod. Please contact the factory for further details.

Rod End Bellows

Exposed rod surfaces that are subjected to air hardening contaminants should be protected by rod end bellows. Longer rod extensions are required to accommodate their collapsed length – please consult the factory for details.

Metallic Rod Wipers

For applications where contaminants may adhere to the extended piston rod and thereby cause premature failure of gland seals, the use of a metallic rod wiper in place of the standard wiper seal is recommended.

Special Designs

Parker's design and engineering staff are available to produce special designs to incorporate customer's specific requirements. Alternative sealing arrangements, special mounting styles, higher or lower rated pressure designs, welded cap ends to reduce overall length (non-cushioned only), larger cylinder bores and alternative rod sizes are just a few of the special requirements which can be accommodated.

Special Mounting Styles

Mounting styles other than those specified in this catalogue can be supplied on request. Please consult the factory.

Rod Material

As an alternative to the normal piston rod material, stainless steel and other special materials and finishes can be supplied.

Marine Environments

MMA cylinders can be supplied with modifications to material and paint specifications which make them suitable for operation in a marine environment. Please consult the factory.

Mounting Information

Mounting Bolts

It is recommended that mounting bolts with a strength to ISO 898/1 grade 12.9 should be used for fixing cylinders to the machine or base. Mounting bolts should be torque loaded to their manufacturer's recommended figures.

Spherical Bearings

All spherical bearings should be re-packed with grease periodically. In unusual or severe working conditions, consult the factory regarding the suitability of the bearing chosen.

Trunnions

On the 320mm bore cylinder the trunnion is welded to the cylinder body. On all other bore sizes the trunnion assembly is threaded to the cylinder body and secured with a locking ring. In both cases, the trunnion pins are machined from solid. If a different requirement is needed to suit a particular application, please consult the factory.

Trunnions require lubricated pillow blocks with minimum bearing clearances. Blocks should be mounted and aligned to eliminate bending moments on the trunnion pins.

Cylinder Masses

The following table shows the masses of MMA cylinders for each mounting style at zero stroke; a stroke adder for each 10mm of stroke can then be calculated. Where applicable, accessory masses can be added to give a gross mass for the complete assembly – see page 13.

Bore Ø	Rod No.	Mounting Styles at Zero Stroke, in kg				per 10mm Stroke kg
		MF3 & MF4	MP3 & MP5	MT4	MS2	
50	1	14.8	16.2	16.6	16.6	0.2
	2	17.8	16.2	16.7	16.6	0.2
63	1	27	26	26	24	0.3
	2	27	26	26	24	0.3
80	1	39	37	37	35	0.5
	2	39	37	37	35	0.5
100	1	61	59	59	56	0.6
	2	61	59	59	56	0.7
125	1	103	103	105	95	0.9
	2	104	104	105	96	1.0
140	1	164	168	171	158	1.1
	2	164	168	171	158	1.2
160	1	198	205	204	188	1.6
	2	199	205	205	188	1.7
180	1	289	290	292	274	2.0
	2	289	291	293	275	2.2
200	1	356	377	363	335	2.2
	2	357	378	364	336	2.4
250	1	646	698	685	614	3.2
	2	647	700	687	616	3.6
320	1	1180	1294	1239	1116	5.1
	2	1230	1345	1290	1118	5.6

Servicing Features

All cylinders will, at some time, need maintenance or repairs. The MMA series has been designed to make these tasks as easy as possible, by incorporating the following design features:

Removable Gland – Rod bearing and rod seals can be replaced without completely dismantling the cylinder. For chevron glands, a thread is machined on the outside diameter of the seal housing to assist extraction.

Chamfers at both ends of the cylinder body ease assembly of the head and cap and insertion of the piston seals.

Retaining flanges are removable, allowing separate replacement of the cylinder body.

High tensile bolts are used for ease of maintenance and replacement.

Flanges are spaced from the head and cap to allow the bolts to be sawn through in the event of severe damage or corrosion.

Head and Cap Retention Bolts

The head and cap retention bolts on MMA Series cylinders are torque loaded on assembly in the factory. If damage or corrosion is found on removal, the old bolts must be discarded and replacement bolts with a minimum strength to ISO 898/1 grade 12.9 must be fitted. Head and cap bolts should always be tightened progressively in a diagonal sequence and torque loaded to the figures shown in the table.

Bore Ø mm	Flange Bolts	
	Torque Load (Nm)	Bolt Size
50	26-28	M8
63	51-54	M10
80	112-118	M12
100	157-165	M14
125	247-260	M16
140		
160	456-480	M20
180		
200	668-692	M22
250	1112-1170	M27
320	1425-1500	M33

Repairs

Although MMA cylinders are designed to make on site maintenance or repairs as easy as possible, some operations should only be carried out in our factory. It is standard policy to fit a cylinder returned to the factory for repair with those replacement parts which are necessary to return it to 'as good as new' condition. Should the condition of the returned cylinder be such that the expense would exceed the cost of a new one, you will be notified.

Check List

This check list indicates the major factors which should be considered when selecting a hydraulic cylinder for a particular application. Further information is available on the pages shown. If additional information is required about any aspect of a cylinder's specification, please contact our design engineers.

inPHorm

The European cylinder inPHorm program (1260-Eur) can assist with the selection and specification of an hydraulic cylinder for a particular application.

1 Establish System Parameters	Series MMA
<ul style="list-style-type: none"> - Mass to be moved and force required - Nominal operating pressure and range - Distance to be travelled - Time available to travel this distance - Fluid medium 	
2 Mounting Style	Page 9
Select the appropriate style for the specific application	
3 Cylinder Bore and Operating Pressure	Page 14
Determine the bore and system pressure required to provide the necessary force	
4 Piston Rod	Page 15
Determine the minimum rod diameter required to withstand buckling forces	
Is a stop tube required?	
Select a suitable rod end and rod end thread	
5 Piston	Page 5
Does seal type suit application?	
6 Cushioning	Page 17
Select cushioning requirements if applicable	
7 Ports	Page 20
Select suitable ports	
Are they capable of the speed required?	
Are the standard positions acceptable?	
8 Seals	Page 19
Select seals to suit the chosen fluid medium	
9 Accessories	Page 13
Are rod end accessories required?	
10 Special Features	Page 6
Mountings, materials, environments and fluids	

Mounting Styles and Where to Find Them

Parker manufactures six standard mounting styles for the MMA range of hydraulic cylinders, to suit the majority of applications. General guidance for selection is given below, with detailed information about each mounting style shown on the pages indicated.

Where a non-standard mounting style is required to satisfy a particular application, our design engineers will be happy to assist. Please contact the factory for details.

Flange Mounted Cylinders

This type of cylinder is suitable for use on straight line force transfer applications. Two mounting styles are available, with flanges at the head or cap. Selection of a particular flange mounting style depends on whether the major force applied to the load will result in compression (push) or tension (pull) stresses on the piston rod. For compression-type applications, cap mounting style MF4 is most appropriate; where the major load places the piston rod in tension, head mounting style MF3 should be specified.

Clevis Mounted Cylinders

Cylinders with pivot mountings, which absorb forces on their centreline, should be used for applications where the machine member to be moved travels in a curved path. They may be used for tension (pull) or compression (push) applications. Fixed clevis mounting cylinders MP3 may be used if the curved path of the piston rod travel is in a single plane; for applications where the piston rod will travel in a path either side of the true plane of motion, the spherical bearing mounting MP5 is recommended.

Trunnion Mounted Cylinders

These cylinders are designed to absorb force on their centre-lines. They are suitable for tension (pull) or compression (push) applications, and may be used where the machine member to be moved travels in a curved path, in a single plane. Trunnion pins are designed for shear loads only and should be subjected to minimum bending stresses.

Foot Mounted Cylinders

MS2 cylinders do not absorb forces on their centreline – see derating note on page 12. As a result, the application of force by the cylinder produces a turning moment which attempts to rotate the cylinder about its mounting bolts. It is important, therefore, that the cylinder should be firmly secured to the machine member on which it is mounted and that the load should be effectively guided, to avoid side loads being applied to the rod gland and piston bearings.

The MS2 foot mounted cylinder is not an ISO standard mounting.

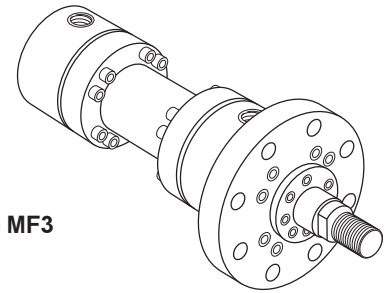

Head Circular Flange MF3
See Page 10

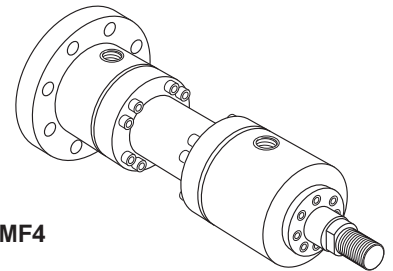

Cap Circular Flange MF4
See Page 10

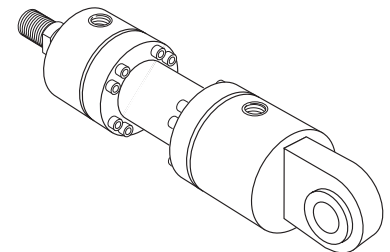

Cap Fixed Eye MP3
See Page 11

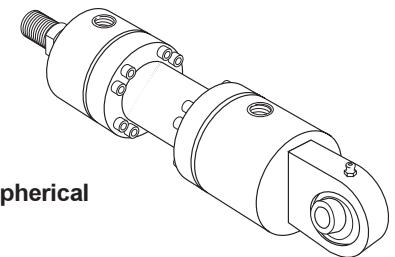

Cap Fixed Eye with Spherical Bearing MP5
See Page 11

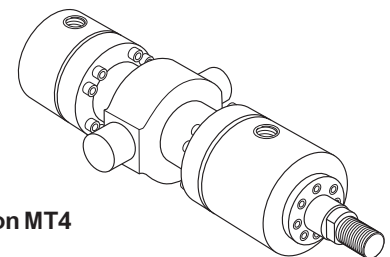

Intermediate Trunnion MT4
See Page 12

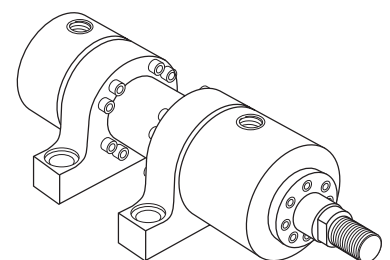

Foot Mounting MS2
See Page 12

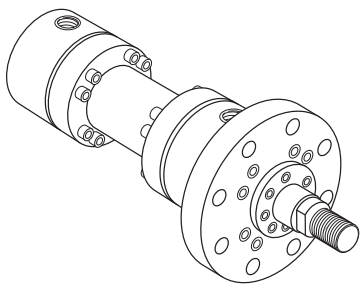

Style MF3
 Head Circular Flange

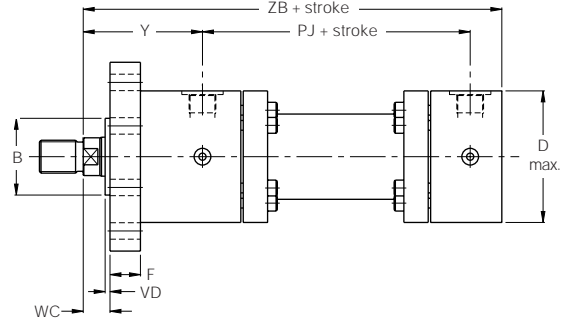
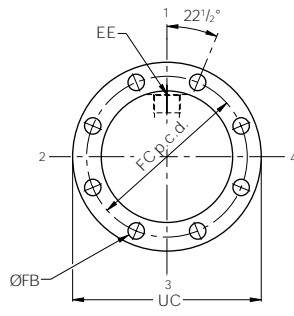

Accurate location of 'B' provided as standard on model MF3 only.

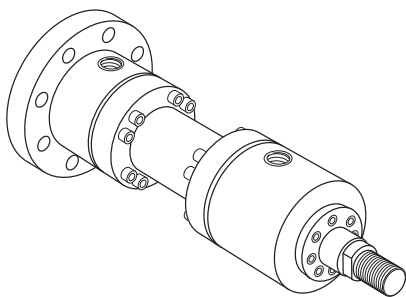

Style MF4
 Cap Circular Flange

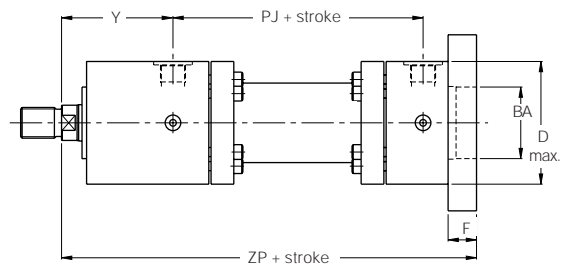
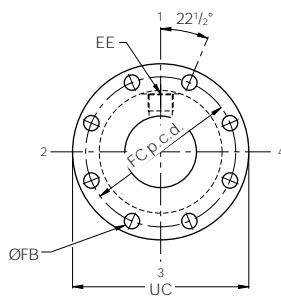

Dimensions – MF3 and MF4 See also Dimensions, page 24 & Mounting Information, page 7

Bore Ø	Rod No.	MM Rod Ø	B ^{FB} & BA ^{HB}	D max.	EE (BSPP)	F	FB	FC	UC	VD min.	WC	Y	Min Stroke	+ Stroke		
														PJ	ZB max.	ZP
50	1	32	63	108	G ^{1/2}	25	13.5	132	155	4	22	98	20	120	244	265
	2	36														
63	1	40	75	124	G ^{3/4}	28	13.5	150	175	4	25	112	30	133	274	298
	2	45														
80	1	50	90	148	G ^{3/4}	32	17.5	180	210	4	28	120	20	155	305	332
	2	56														
100	1	63	110	175	G ¹	36	22	212	250	5	32	134	25	171	340	371
	2	70														
125	1	80	132	208	G ¹	40	22	250	290	5	36	153	50	205	396	430
	2	90														
140 ¹	1	90	145	255	G ^{1 1/4}	40	26	300	340	5	36	181	50	208	430	465
	2	100														
160	1	100	160	270	G ^{1 1/4}	45	26	315	360	5	40	185	50	235	467	505
	2	110														
180 ¹	1	110	185	315	G ^{1 1/4}	50	33	365	420	5	45	205	20	250	505	550
	2	125														
200	1	125	200	330	G ^{1 1/4}	56	33	385	440	5	45	220	20	278	550	596
	2	140														
250	1	160	250	412	G ^{1 1/2}	63	39	475	540	8	50	260	20	325	652	703
	2	180														
320	1	200	320	510	G ²	80	45	600	675	8	56	310	20	350	764	830
	2	220														

¹ 140mm and 180mm bore cylinders do not conform to ISO 6022

All dimensions are in millimetres unless otherwise stated.

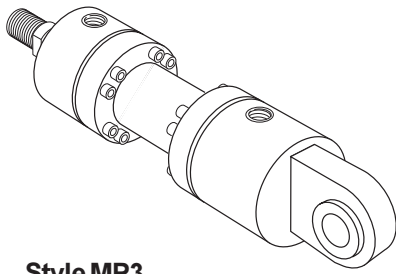

Style MP3
 Cap Fixed Eye

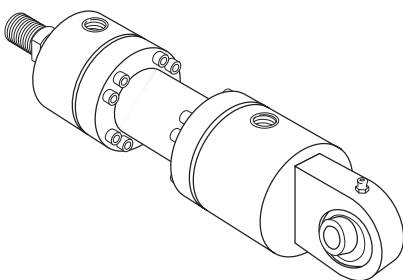
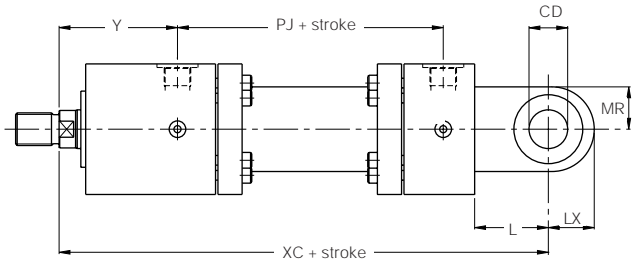
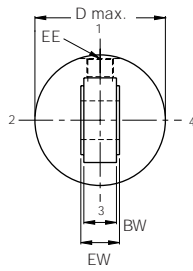

Style MP5
 Cap Fixed Eye
 with Spherical Bearing

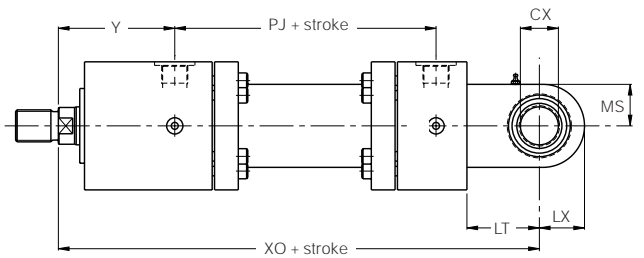
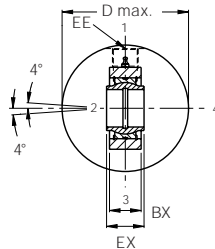

Dimensions – MP3 and MP5 See also Dimensions, page 24 & Mounting Information, page 7

Bore Ø	Rod No.	MM Rod Ø	BW & BX	CD ^{H9} & CX ^{H7}	D max.	EE (BSPP)	EW ^{h12} & EX ^{h12}	L & LT	LX	MR & MS	Y	Min Stroke	+ Stroke	
													PJ	XC & XO
50	1 2	32 36	27	32	108	G $\frac{1}{2}$	32	61	38	35	98	20	120	305
63	1 2	40 45	35	40	124	G $\frac{3}{4}$	40	74	50	50	112	30	133	348
80	1 2	50 56	40	50	148	G $\frac{3}{4}$	50	90	61.5	61.5	120	20	155	395
100	1 2	63 70	52	63	175	G1	63	102	71	66	134	25	171	442
125	1 2	80 90	60	80	208	G1	80	124	90	90	153	50	205	520
140 ¹	1 2	90 100	65	90	255	G $1\frac{1}{4}$	90	150	113	113	181	50	208	580
160	1 2	100 110	84	100	270	G $1\frac{1}{4}$	100	150	112	117.5	185	50	235	617
180 ¹	1 2	110 125	88	110	315	G $1\frac{1}{4}$	110	185	129	118	205	20	250	690
200	1 2	125 140	102	125	330	G $1\frac{1}{4}$	125	206	145	131	220	20	278	756
250	1 2	160 180	130	160	412	G $1\frac{1}{2}$	160	251	178	163	260	20	325	903
320	1 2	200 220	162	200	510	G2	200	316	230	209	310	20	350	1080

¹ 140mm and 180mm bore cylinders do not conform to ISO 6022

All dimensions are in millimetres unless otherwise stated.

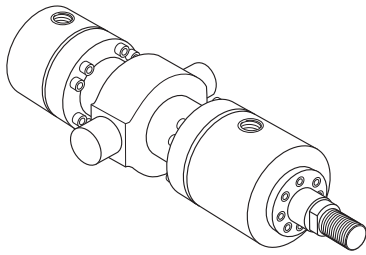

Style MT4
 Intermediate Trunnion

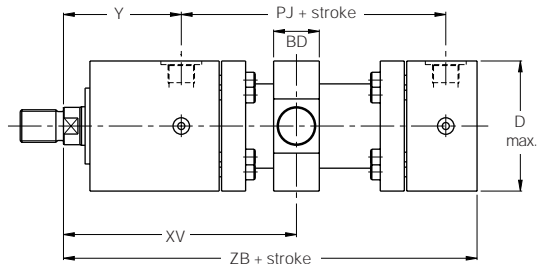
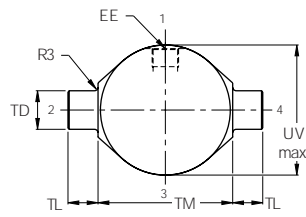

Note: XV Dimension to be specified by customer. Where minimum dimension is unacceptable, please consult factory.

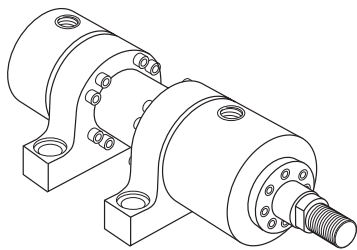

Style MS2
 Foot Mounting
 (Not to ISO 6022)

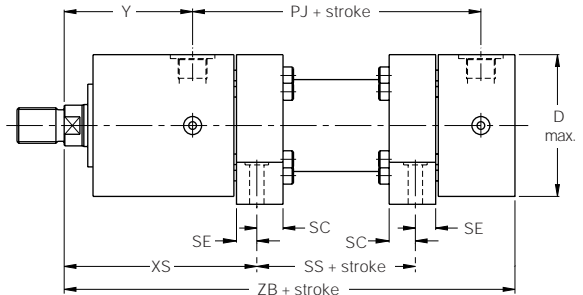
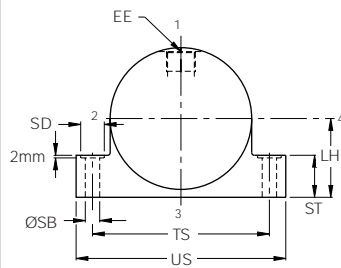

Note: The MS2 mounting should only be used where the stroke is at least half of the bore diameter or where the cylinder operates below 160 bar.

Dimensions – MT4 See also Dimensions, page 24 & Mounting Information, page 7

Bore Ø	Rod No.	MM Rod Ø	BD	D max.	EE (BSPP)	TD ^{f8}	TL	TM ^{h13}	UV max.	XV min.	Y	Min Stroke	+ Stroke		
													PJ	XV max.	ZB max.
50	1 2	32 36	38	108	G ¹ / ₂	32	25	112	108	187	98	55	120	132	244
63	1 2	40 45	48	124	G ³ / ₄	40	32	125	124	212	112	75	133	137	274
80	1 2	50 56	58	148	G ³ / ₄	50	40	150	148	245	120	90	155	155	305
100	1 2	63 70	73	175	G1	63	50	180	175	280	134	120	171	160	340
125	1 2	80 90	88	208	G1	80	63	224	218	340	153	160	205	180	396
140 ¹	1 2	90 100	98	255	G1 ¹ / ₄	90	70	265	260	380	181	180	208	200	430
160	1 2	100 110	108	270	G1 ¹ / ₄	100	80	280	280	400	185	180	235	220	467
180 ¹	1 2	110 125	118	315	G1 ¹ / ₄	110	90	320	315	410	205	170	250	240	505
200	1 2	125 140	133	330	G1 ¹ / ₄	125	100	335	330	450	220	190	278	260	550
250	1 2	160 180	180	412	G1 ¹ / ₂	160	125	425	412	540	260	240	325	300	652
320	1 2	200 220	220	510	G2	200	160	530	510	625	310	300	350	325	764

¹ 140mm and 180mm bore cylinders do not conform to ISO 6022

All dimensions are in millimetres unless otherwise stated.

Dimensions – MS2 See also Dimensions, page 24 & Mounting Information, page 7

Bore Ø	Rod No.	MM Rod Ø	D max.	EE (BSPP)	LH ^{h10}	SB ^{H13}	SC	SD	SE	ST	TS	US	XS	Y	Min Stroke	+ Stroke		
																PJ	SS	ZB max.
50	1 2	32 36	108	G ^{1/2}	60	11	20.5 ²	18	15.5	32	135	160	130.0	98	0	120	55	244
63	1 2	40 45	124	G ^{3/4}	68	13.5	24.5 ²	20	17.5	37	155	185	147.5	112	20	133	55	274
80	1 2	50 56	148	G ^{3/4}	80	17.5	22.5	26	22.5	42	185	225	170.5	120	35	155	55	305
100	1 2	63 70	175	G1	95	22	27.5	33	27.5	52	220	265	192.5	134	55	171	55	340
125	1 2	80 90	208	G1	115	26	30.0	40	30.0	62	270	325	230.0	153	65	205	60	396
140 ¹	1 2	90 100	255	G1 ^{1/4}	135	30	35.5	48	35.5	77	325	390	254.5	181	80	208	61	430
160	1 2	100 110	270	G1 ^{1/4}	145	33	37.5	48	37.5	77	340	405	265.5	185	80	235	79	467
180 ¹	1 2	110 125	315	G1 ^{1/4}	165	40	42.5	60	42.5	87	390	465	287.5	205	70	250	85	505
200	1 2	125 140	330	G1 ^{1/4}	170	40	47.0 ²	60	45.0	87	405	480	315.0	220	60	278	90	550
250	1 2	160 180	412	G1 ^{1/2}	215	52	52.0 ²	76	50.0	112	520	620	360.0	260	60	325	120	652
320	1 2	200 220	510	G2	260	62	62.0 ²	110	60.0	152	620	740	425.0	310	80	350	120	764

¹ 140mm and 180mm bore cylinders do not conform to ISO 6022

² Mounting holes offset from centre line

Rod End Accessories

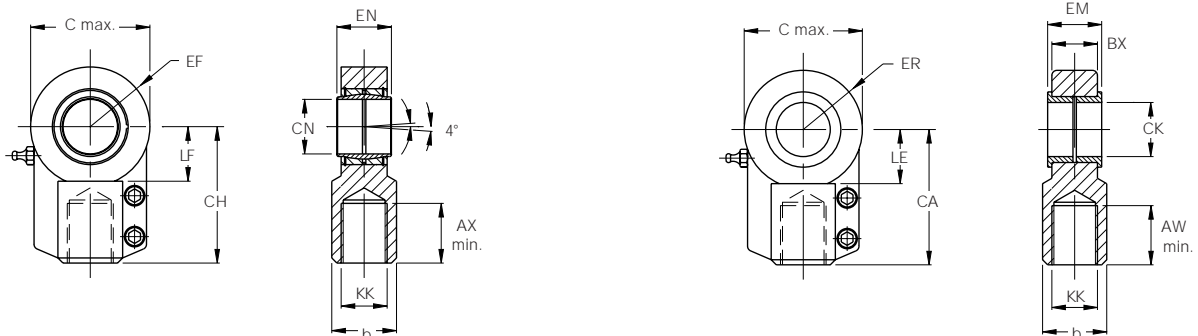

Rod Eye with Spherical Bearing – ISO 6982

Rod Eye with Plain Bearing – ISO 6981

Dimensions See also Mounting Information, page 7

Bore Ø	KK	Spherical Bearing Part No.	Plain Bearing Part No.	AX min. & AW min.	CN ^{H7} & CK ^{H9}	EN ^{h12} & EM ^{h12}	CH & CA	LF & LE	C max.	EF & ER	BX	b	Torque Load Nm	Mass kg
50	M27 x 2	145241	148731	37	32	32	80	32	76	40	27	38	32	1.2
63	M33 x 2	145242	148732	46	40	40	97	41	97	50	32	47	32	2.1
80	M42 x 2	145243	148733	57	50	50	120	50	118	63	40	58	64	4.4
100	M48 x 2	145244	148734	64	63	63	140	62	142	71	52	70	80	7.6
125	M64 x 3	145245	148735	86	80	80	180	78	180	90	66	90	195	14.5
140	M72 x 3	148723	148736	91	90	90	195	85	185	101	72	100	195	17
160	M80 x 3	148724	148737	96	100	100	210	98	224	112	84	110	385	28
180	M90 x 3	148725	148738	106	110	110	235	105	235	129	88	125	385	32
200	M100 x 3	148726	148739	113	125	125	260	120	290	160	103	135	385	43
250	M125 x 4	148727	148740	126	160	160	310	150	346	200	130	165	660	80
320	M160 x 4	148728	148741	161	200	200	390	195	460	250	162	215	1350	165

All dimensions are in millimetres unless otherwise stated.

Calculation of Cylinder Diameter

Given that the load and operating pressure of the system are known, and that a piston rod size has been estimated taking account of whether the rod is in tension (pull) or compression (push), then the cylinder bore can be selected.

If the piston rod is in compression, use the 'Push Force' table below.

1. Identify the operating pressure closest to that required.
2. In the same column, identify the force required to move the load (always rounding up).
3. In the same row, look along to the cylinder bore required.

If the cylinder envelope dimensions are too large for your application increase the operating pressure, if possible, and repeat the exercise.

If the piston rod is in tension, use the 'Deduction for Pull Force' table. The procedure is the same but, due to the reduced piston surface area resulting from the piston rod, the force available on the 'pull' stroke will be smaller.

To determine the pull force:

1. Follow the procedure for 'Push' applications, as described above.
2. Using the 'Deduction for Pull Force' table below, establish the force indicated according to the rod diameter and pressure selected.
3. Deduct this from the original 'Push' force. The resulting figure is the net force available to move the load.

If this force is not large enough, go through the process again but increase the system operating pressure or cylinder diameter if possible. If in doubt, our design engineers will be pleased to assist.

Push Force

Bore Ø mm	Cylinder Bore Area mm ²	Cylinder Push Force in kN at Various Pressures				
		50 Bar	100 Bar	150 Bar	200 Bar	250 Bar
50	1964	10	20	30	40	50
63	3117	15	31	46	63	79
80	5026	25	51	76	102	128
100	7854	40	80	120	160	200
125	12272	62	125	187	250	312
140	15386	77	154	231	308	385
160	20106	102	205	307	410	512
180	25434	127	254	381	508	635
200	31416	160	320	480	640	801
250	49087	250	500	750	1000	1250
320	80425	410	820	1230	1640	2050

Deduction for Pull Force

Piston Rod Ø mm	Piston Rod Area mm ²	Reduction in Force in kN due to Area of Piston Rod at Various Pressures				
		50 Bar	100 Bar	150 Bar	200 Bar	250 Bar
32	804	4	8	12	16	20
36	1018	5	10	15	20	25
40	1257	6	12	19	24	31
45	1590	8	16	24	32	40
50	1964	10	19	29	38	49
56	2463	12	25	37	50	62
63	3386	17	34	51	68	85
70	3848	19	39	58	78	98
80	5027	25	50	76	100	126
90	6362	32	64	97	129	162
100	7855	39	79	118	158	196
110	9503	48	96	145	193	242
125	12274	61	123	184	246	307
140	15394	78	156	235	313	392
160	20109	100	201	301	402	503
180	25447	129	259	389	518	648
200	31420	157	314	471	628	785
220	38013	198	387	581	775	969

inPHorm

For more comprehensive information on the calculation of cylinder bore size required, please refer to the European cylinder inPHorm selection program (1260-Eur).

Piston Rod Size Selection

The selection of a piston rod for thrust (push) conditions requires the following steps to be carried out.

1. Determine the type of cylinder mounting style and rod end connection to be used. Consult the Stroke Factor Selection table on page 16 and determine which factor corresponds to the application.

2. Using the stroke factor, determine the 'basic length' from the equation:

$$\text{Basic Length} = \text{Actual (net) Stroke} \times \text{Stroke Factor}$$

(The Piston Rod Selection Chart, below, applies to piston rods with standard rod extensions beyond the face of the gland retainer. For rod extensions greater than standard, add the increase to the stroke to arrive at the 'basic length'.)

3. Find the load imposed for the thrust application by multiplying the full bore area of the cylinder by the system pressure, or by referring to the Push and Pull Force charts on page 14.
4. Using the Piston Rod Selection Chart, below, look along the values for 'basic length' and 'thrust' as found in 2. and 3. above, and note the point of intersection.

The correct piston rod size is read from the diagonally curved line labelled 'Rod Diameter' above the point of intersection.

Long Strokes and Stop Tubes

When considering the use of long stroke cylinders, the piston rod should be of sufficient diameter to provide the necessary column strength.

For tension (pull) loads, the rod size is selected by specifying standard cylinders with standard rod diameters, and using them at or below the rated pressure.

For long stroke cylinders under compressive loads, the use of stop tubes should be considered, to reduce bearing stress. Selection of a stop tube is described on page 16.

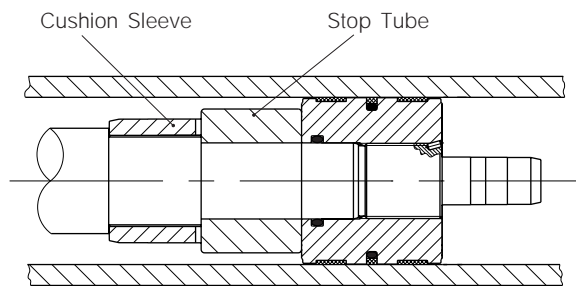

inPHorm

For accurate sizing, please refer to the European cylinder inPHorm selection program (1260-Eur).

Piston Rod Selection Chart

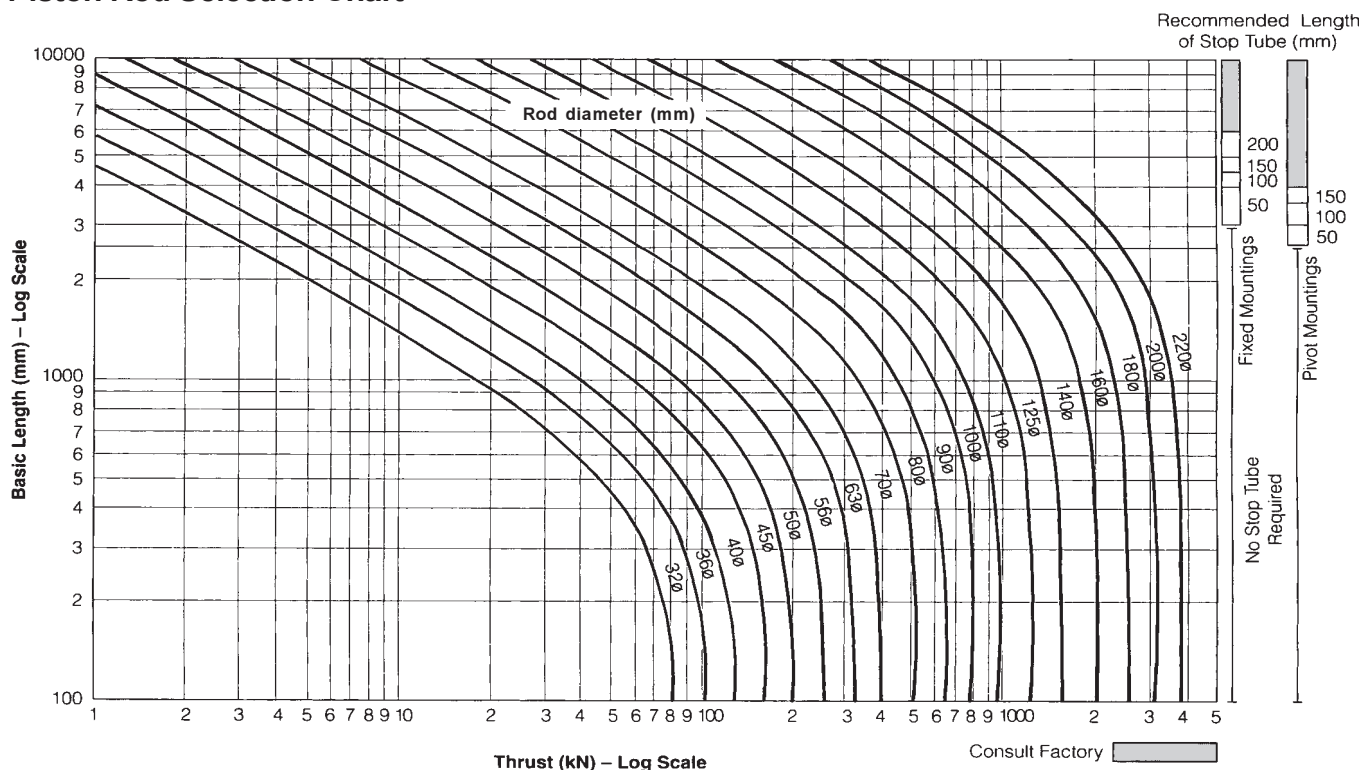

Stop Tubes

The Piston Rod Selection Chart on page 15 indicates where the use of a stop tube should be considered. The required length of stop tube, where necessary, is read from the vertical columns on the right of the chart, by following the horizontal band within which the point of intersection lies. Note that stop tube requirements differ for fixed and pivot mounted cylinders.

If the required length of stop tube is in the shaded region marked 'consult factory', please submit the following information:

1. Cylinder mounting style.
2. Rod end connection and method of guiding load.
3. Bore and stroke required, and length of rod extension (Dimension 'W') if greater than standard.
4. Mounting position of cylinder. If at an angle or vertical, specify the direction of the piston rod.





5. Operating pressure of the cylinder if limited to less than the standard pressure for the cylinder selected.

When specifying a cylinder with a stop tube, please insert an 'S' (Special) and the **net** stroke of the cylinder in the order code and state the length of the stop tube. Note that net stroke is equal to the gross stroke of the cylinder less the length of the stop tube. The gross stroke determines the envelope dimensions of the cylinder.

inPHorm

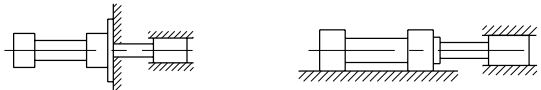
For accurate sizing, please refer to the European cylinder inPHorm selection program (1260-Eur).

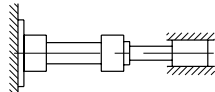
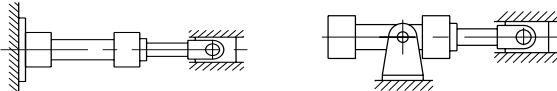
Stroke Factor Selection

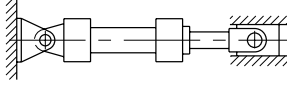
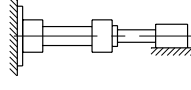
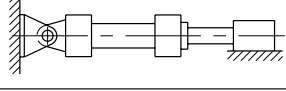
Rod End Connection	Style	Type of Mounting	Stroke Factor
Fixed and Rigidly Guided	MF3 MS2		0.5
Pivoted and Rigidly Guided	MF3 MS2		0.7
Fixed and Rigidly Guided	MF4		1.0
Pivoted and Rigidly Guided	MF4 MT4		1.5
Supported but Not Rigidly Guided	MS2		2.0
Pivoted and Rigidly Guided	MP3 MP5		2.0
Supported but Not Rigidly Guided	MF4		4.0
Supported but Not Rigidly Guided	MP3 MP5		4.0

An Introduction to Cushioning

Cushioning is recommended as a means of controlling the deceleration of masses, or for applications where piston speeds are in excess of 0.1m/s and the piston will make a full stroke. Cushioning extends cylinder life and reduces undesirable noise and hydraulic shock.

Built-in deceleration devices or 'cushions' are optional and can be supplied at the head and cap ends of the cylinder without affecting its envelope or mounting dimensions. Cushions are adjustable via recessed needle valves.

Standard Cushioning

Ideal cushion performance shows an almost uniform absorption of energy along the cushion's length. Many forms of cushioning exist and each has its own specific merits and advantages. Where specified, the standard form of cushioning for MMA cylinders uses profiled cushions, giving a performance which comes close to the ideal in the majority of applications. The head and cap cushion performance for each bore size is illustrated graphically on the charts on page 18.

Alternative Forms of Cushioning

As an alternative to profiled cushions, special designs can be produced to suit applications where the energy to be absorbed exceeds the standard cushion performance. Please consult the factory with details of the application.

Cushion Length

All MMA cylinder cushions incorporate the longest cushion sleeve and spear that can be provided in the standard envelope without decreasing the rod bearing and piston bearing lengths – see table of cushion lengths on page 18.

Cushion Calculations

The charts on page 18 show the energy absorption capacity for each bore and rod combination at the head (annulus) and the cap (full bore) ends of the cylinder. The charts are valid for piston velocities in the range of 0.1–0.3m/s. For velocities between 0.3m/s–0.5m/s, the energy values from the charts should be reduced by 25%. For velocities of less than 0.1m/s where large masses are involved, and for velocities greater than 0.5m/s, a special cushion profile may be required. Please consult the factory.

The cushion capacity of the head end is less than that of the cap, owing to the pressure intensification effect across the piston.

The energy absorption capacity of the cushion decreases with drive pressure, which in normal circuits is the relief valve setting.

inPHorm

Cushioning requirements can be calculated automatically for individual cylinder/load combinations using the European cylinder inPHorm selection program (1260-Eur).

Formulae

Cushioning calculations are based on the formula: $E = \frac{1}{2}mv^2$ for horizontal applications. For inclined or vertically downward or upward applications, this is modified to:

$E = \frac{1}{2}mv^2 + mgl \times 10^{-3} \times \sin\alpha$
– for inclined or vertically downward direction of mass;

$E = \frac{1}{2}mv^2 - mgl \times 10^{-3} \times \sin\alpha$
– for inclined or vertically upward direction of mass.

Where:

- E = energy absorbed in Joules
- g = acceleration due to gravity = 9.81m/s²
- v = velocity in metres/second
- l = length of cushion in millimetres (see page 18)
- m = mass of load in kilogrammes (including piston and rod, see page 18)
- α = angle to horizontal in degrees
- p = pressure in bar

Example

The following example shows how to calculate the energy developed by masses moving in a straight line. For non-linear motion, other calculations are required; please consult the factory. The example assumes that the bore and rod diameters are already appropriate for the application.

The effects of friction on the cylinder and load have been ignored.

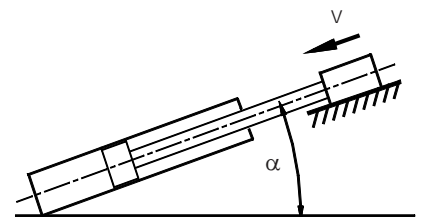

Selected bore/rod = 80/50mm (No.1 rod)

Cushioning at the cap end

- Pressure = 150 bar
- Mass = 7710 kg
- Velocity = 0.4m/s
- α = 45°
- Sinα = 0.7
- Cushion length = 45mm

$E = \frac{1}{2}mv^2 + mgl \times 10^{-3} \times \sin\alpha$

$E = \frac{7710 \times 0.4^2}{2} + 7710 \times 9.81 \times \frac{45}{10^3} \times 0.7$

$E = 617 + 2383 = 3000 \text{ Joules}$

Note: as velocity is greater than 0.3m/s, the energy absorption figures obtained from the charts on page 18 should be reduced by 25% – see Cushion Calculations, opposite. Comparison with the cushioning chart curve for this cylinder shows an energy capacity for the cap end cushion of 5100 J. Reducing this by 25% gives a capacity of 3825 J, so the standard cushion can safely decelerate the 3000 J in this example. Where cushion performance figures are critical, our engineers can run a computer simulation to determine accurate cushion performance – please contact the factory for details.

Cushion Energy Absorption Data

The cushion energy absorption capacity data shown below are based on the maximum fatigue-free pressures developed in the cylinder tube. If working life cycle applications of less than 10⁶ cycles are envisaged, then greater energy absorption figures can be applied. Please consult the factory if further information is required.

Where cushion performance figures are critical, our engineers can run a computer simulation to determine accurate cushion performance – please contact the factory for details.

Head End, No.1 Rod

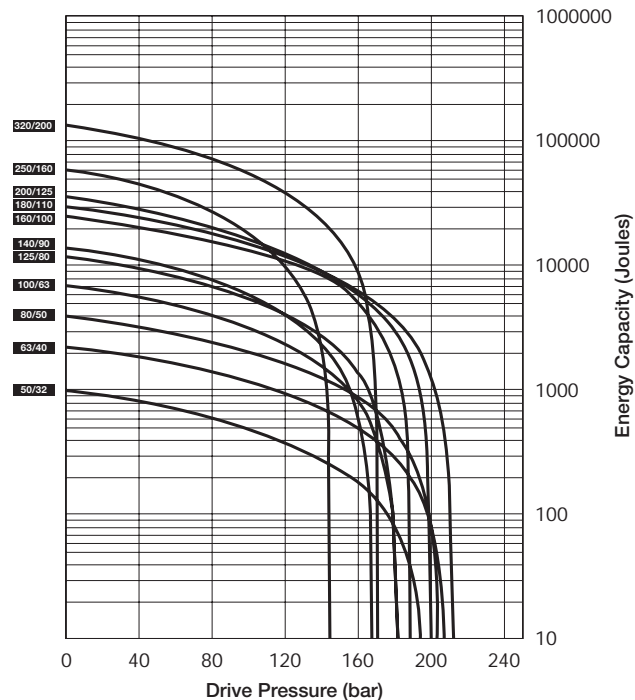

Head End, No.2 Rod

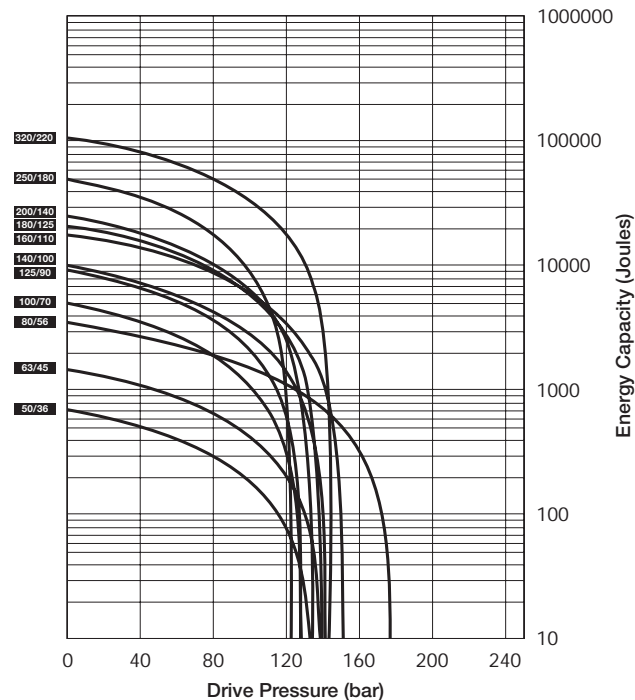

Cap End, No.1 and No.2 Rods

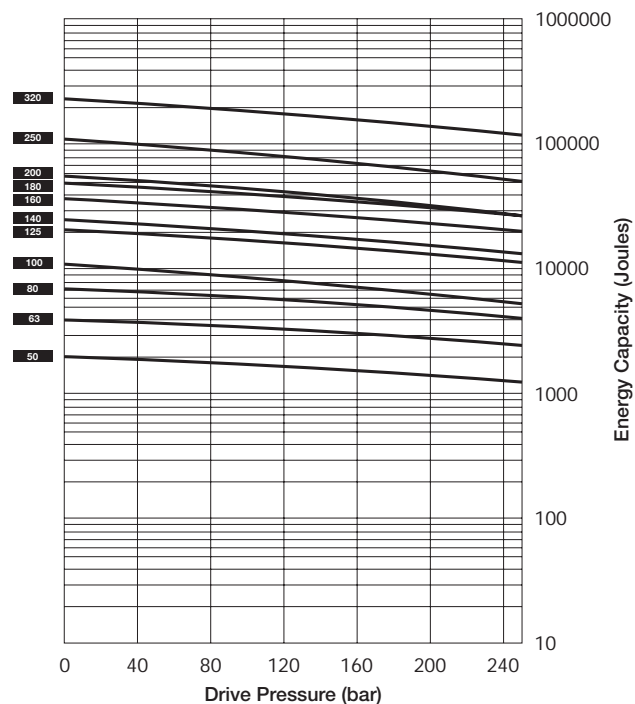

Cushion Length, Piston & Rod Mass

Bore Ø mm	Rod No.	Rod Ø mm	Cushion Length mm	Piston & Rod Zero Stroke kg	Rod per 10mm Stroke kg
50	1	32	30	2.0	0.06
	2	36		2.3	0.08
63	1	40	40	3.4	0.10
	2	45		4.0	0.12
80	1	50	45	5.8	0.15
	2	56		6.7	0.19
100	1	63	55	10.7	0.24
	2	70		12.1	0.30
125	1	80	60	20.7	0.39
	2	90		23.8	0.50
140	1	90	60	28.0	0.50
	2	100		31.0	0.62
160	1	100	65	40.1	0.62
	2	110		44.6	0.75
180	1	110	65	54.0	0.75
	2	125		62.0	0.96
200	1	125	65	76.2	0.96
	2	140		86.0	1.23
250	1	160	90	131.8	1.58
	2	180		150.2	2.00
320	1	200	100	250.2	2.46
	2	220		279.7	2.98

Seals and Fluid Data

Group	Seal Materials – a combination of:	Fluid Medium to ISO 6743/4-1982	Piston & Gland Type	Temperature Range
1	Nitrile (NBR), PTFE, enhanced polyurethane (AU)	Mineral Oil HH, HL, HLP, HLPD, HM, HV, MIL-H 5606 oil, air, nitrogen	All	-20°C to +80°C
2	Nitrile (NBR), PTFE	Water glycol (HFC)	Chevron and Low Friction	-20°C to +60°C
5	Fluorocarbon elastomer (FPM), PTFE	Fire resistant fluids based on phosphate esters (HFD-R) Also suitable for hydraulic oil at high temperatures or in hot environments. Not suitable for use with Skydrol. See fluid manufacturer's recommendations	Chevron and Low Friction	-15°C to +150°C
6	Various compounds including nitrile, enhanced polyurethane, fluorocarbon elastomers and PTFE	Water Oil in water emulsion 95/5 (HFA)	Chevron and Low Friction	+5°C to +50°C
7		Water in oil emulsion 60/40 (HFB)	Chevron and Low Friction	+5°C to +50°C

Operating Medium

The Group 1 seal materials supplied with standard cylinders are suitable for use with any petroleum-based hydraulic fluid. Special seals are available for use with fluids such as fire resistant synthetic phosphate ester, and phosphate ester-based fluids. If there is any doubt regarding seal compatibility with the operating medium, please consult the factory.

The table above is a guide to commonly used sealing compounds and their operating parameters.

Temperature

Standard seals are suitable for use at temperatures between -20°C and +80°C. Where operating temperatures exceed these limits, special seal compounds may be required to ensure satisfactory service life – please consult the factory.

Special Seals

A range of seal options is available for the fluid groups listed above – see cylinder model numbers on page 25. Where required, special seals, in addition to those shown above, can also be supplied. Please insert an S (Special) in the model number and specify fluid medium when ordering.

Group 6 Seal Life

Seals used with High Water Content Fluids (HFA) are prone to wear due to the poor lubricity of the operating medium. This problem increases with pressure. These seals are best used where high pressure is applied only to clamp the load. If pressures above 120 bar are applied when the cylinder is actuating, seal life will be significantly reduced. Seal wear can also be affected by the particular HFA fluid specified.

Water Service

Special modifications to cylinders are available for high water content fluids. Modifications include a stainless steel piston rod, and plating of internal surfaces. When ordering, please specify the maximum operating pressure or load/speed conditions, as the stainless steel rod is of lower tensile strength than the standard material.

Pure Water

Parker Hannifin can also supply cylinders for use with pure water as the fluid medium. Please consult the factory.

Warranty Parker Hannifin warrants cylinders modified for water or high water content fluid service to be free of defects in materials or workmanship, but cannot accept responsibility for premature failure caused by excessive wear resulting from lack of lubricity, or where failure is caused by corrosion, electrolysis or mineral deposits within the cylinder.

Filtration

For maximum component life, the system should be protected from contamination by effective filtration. Fluid cleanliness should be in accordance with ISO 4406. The quality of filters should be in accordance with the appropriate ISO standards.

The rating of the filter media depends on the system components and the application. The minimum required for hydraulic systems should be class 19/15 to ISO 4406, which equates to 25µ (β10≥75) to ISO 4572.

Ports

Port Types

Standard and Oversize Ports

Parker MMA cylinders are supplied as standard with BSP (parallel thread) ports to ISO 228/1, spot faced for sealing washers.

Where required, oversize or additional ports can be supplied on the sides of heads or caps that are not occupied by cushion valves. Refer to the tables of port sizes on page 20.

Optional Ports

In addition to the standard and oversize BSPP ports, metric threaded ports to DIN 3852 Pt.1 and ISO 6149, and flange ports to ISO 6162 (1994) can also be supplied – see table opposite. Other flange port styles are available on request.

Flange Port Sizes

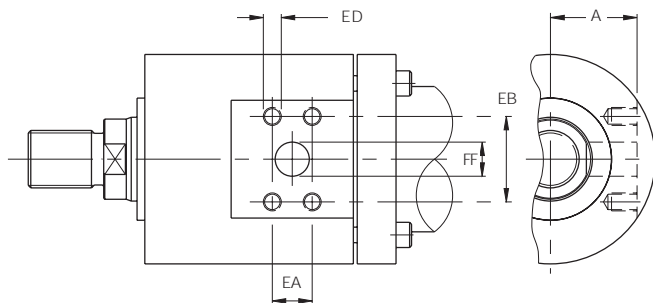

Bore Ø mm	Standard Port			Oversize Port		
	BSP	Metric	DN Flange	BSP	Metric	DN Flange
50	G ¹ / ₂	M22 x 1.5	13	G ³ / ₄	M27 x 2	*
63	G ³ / ₄	M27 x 2	13	G1	M33 x 2	*
80	G ³ / ₄	M27 x 2	13	G1	M33 x 2	19
100	G1	M33 x 2	19	G1 ¹ / ₄	M42 x 2	25
125	G1	M33 x 2	19	G1 ¹ / ₄	M42 x 2	25
140	G1 ¹ / ₄	M42 x 2	25	G1 ¹ / ₂	M48 x 2	32
160	G1 ¹ / ₄	M42 x 2	25	G1 ¹ / ₂	M48 x 2	32
180	G1 ¹ / ₄	M42 x 2	25	G1 ¹ / ₂	M48 x 2	32
200	G1 ¹ / ₄	M42 x 2	25	G1 ¹ / ₂	M48 x 2	32
250	G1 ¹ / ₂	M48 x 2**	32	G2	M60 x 2	38
320	G2	M60 x 2	32	-	-	38

* Consult factory

** An M50 thread to DIN 24 333 can be supplied if required.

ISO 6149 Port Identification

The ISO 6149 port incorporates a raised ring in the spot face for identification, as shown below.

Raised ring within spot face

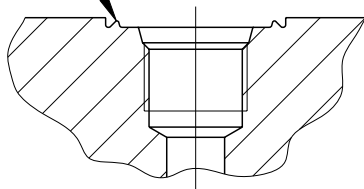

Bore Ø mm	Standard Flange Port					
	DN Flange ¹	A	EA	EB	ED	FF Ø
50	13	47	17.5	38.1	M8 x 1.25	13
63	13	55				
80	13	68				
100	19	80	22.2	47.6	M10 x 1.5	19
125	19	97				
140	25	121	26.2	52.4	M10 x 1.5	25
160	25	129				
180	25	152				
200	25	160				
250	32	201	30.2	58.7	M12 x 1.75 ²	32
320	32	250				

Bore Ø mm	Oversize Flange Port					
	DN Flange ¹	A	EA	EB	ED	FF Ø
50	-	-	-	-	-	-
63	-	-	-	-	-	-
80	19	66	22.2	47.6	M10 x 1.5	19
100	25	79				
125	25	97	26.2	52.4	M10 x 1.5	25
140	32	120				
160	32	128				
180	32	151				
200	32	159	30.2	58.7	M12 x 1.75 ²	32
250	38 ³	197 ³				
320	38 ³	248 ³	36.5 ³	79.3 ³	M16 x 2 ³	38 ³

¹ 25 bar to 350 bar series

² M10 x 1.5 to ISO 6162 (1994) optional

³ 400 bar series

Port Size and Piston Speed

One of the factors involved in determining the speed of a hydraulic cylinder is fluid flow in connecting lines, particularly at the cap end port, due to the absence of a piston rod. Fluid velocity in connecting lines should be limited to 5m/s to minimise fluid turbulence, pressure loss and water hammer effects. The tables below are a guide for use when determining whether cylinder ports are adequate for the application. Data shown gives piston speeds for standard and oversize ports and connecting lines where the velocity of the fluid is 5m/s. If the desired piston speed results in a fluid flow in excess of 5m/s in connecting lines, larger lines with two ports per cap should be considered. Parker recommends that a flow rate of 12m/s in connecting lines should not be exceeded.

Bore Ø mm	Standard Cylinder Port			
	Port Size (BSPP)	Bore of Connecting Lines mm	Cap End Flow in l/min at 5m/s ¹	Piston Speed m/s
50	G ¹ / ₂	13	40	0.34
63	G ³ / ₄	15	53	0.28
80	G ³ / ₄	15	53	0.18
100	G1	19	85	0.18
125	G1	19	85	0.12
140	G1 ¹ / ₄	22	114	0.12
160	G1 ¹ / ₄	22	114	0.10
180	G1 ¹ / ₄	22	114	0.08
200	G1 ¹ / ₄	22	114	0.06
250	G1 ¹ / ₂	28	185	0.06
320	G2	38	340	0.07

Bore Ø mm	Oversize Cylinder Port			
	Port Size	Bore of Connecting Lines mm	Cap End Flow in l/min at 5m/s ¹	Piston Speed m/s
50	G ³ / ₄	14	53	0.45
63	G1	19	85	0.46
80	G1	19	85	0.28
100	G1 ¹ / ₄	22	114	0.24
125	G1 ¹ / ₄	22	114	0.16
140	G1 ¹ / ₂	28	185	0.20
160	G1 ¹ / ₂	28	185	0.15
180	G1 ¹ / ₂	28	185	0.12
200	G1 ¹ / ₂	28	185	0.10
250	G2	38	340	0.12
320	-	-	-	-

¹ This refers to fluid velocity in connecting lines, not piston velocity

Ports, Air Bleeds and Cushion Adjustment Location

Standard port location is position 1, as shown on pages 10 to 12. Cushion adjustment needle valves are at position 2.

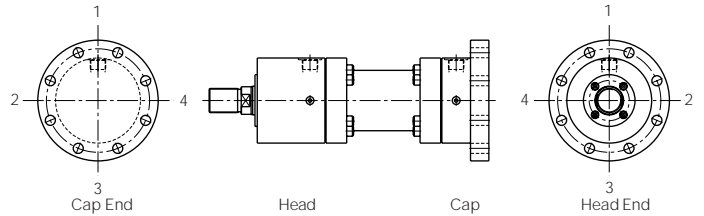

The port location can be repositioned at 90° or 180° from standard. To order non-standard port locations, specify using position numbers from the drawing above. In these cases, the cushion adjustment needle valves rotate accordingly, unless otherwise specified.

Captive bleed screws are available in the head and cap as an option. The air bleed location, in relation to the supply port location, must be specified on the order. Air bleeds are available at all positions.

inPHorm

For accurate sizing, please refer to the European cylinder inPHorm selection program (1260-Eur).

Service Assemblies and Seal Kits

Service Assembly Kits and Seal Kits for MMA cylinders simplify the ordering and maintenance processes. They contain sub-assemblies which are ready for installation, and are supplied with full instructions. When ordering Service Assemblies and Seal Kits, please refer to the identification plate on the cylinder body, and supply the following information:

Serial Number - Bore - Stroke - Model Number - Fluid Type

Key to Part Numbers

- 1 Head
- 7 Cap
- 14a Standard and Low Friction gland
- 14b Chevron gland
- 15 Cylinder tube
- 17 Piston
- 17a Chevron piston – head end
- 17b Chevron piston – cap end
- 18 Cushion sleeve
- 19 Front/rear flange
- 23 Head/cap securing screw
- 26 O-ring (cylinder body)

- 124 Pre-load ring for stepseal 123
- 125 Standard piston seal
- 126 Energising ring for standard seal 125
- 127 Wear ring for standard piston
- 131 Low Friction piston seal
- 132 Energising ring for Low Friction piston seal 131
- 133 Wear ring for Low Friction piston
- 134 O-ring back up washer (gland/head)
- 136 Gland securing screw
- 137 Chevron rod seal assembly
- 138 Back up washer – Chevron rod seal assembly
- 139a Wear ring for chevron gland
- 139b Wear rings for chevron gland
- 140a Wear ring for standard gland
- 140b Wear rings for standard gland
- 141a Wear ring for Low Friction gland
- 141b Wear rings for Low Friction gland
- 142 Chevron piston bearing ring
- 143 Chevron piston seal assembly

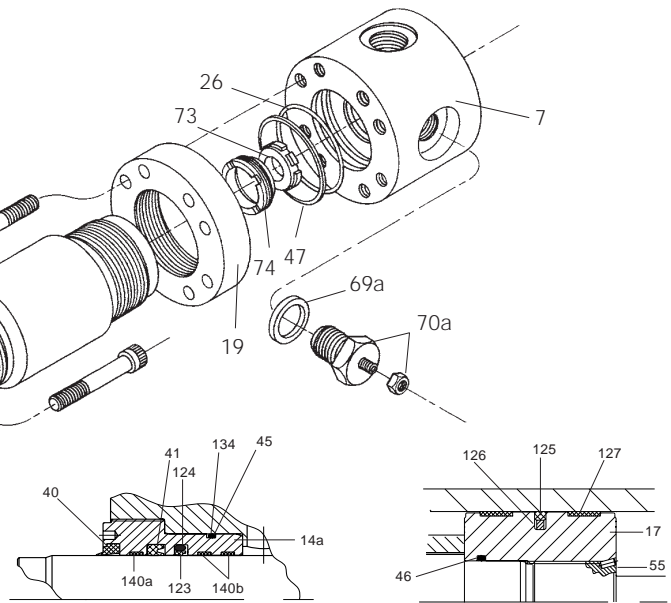
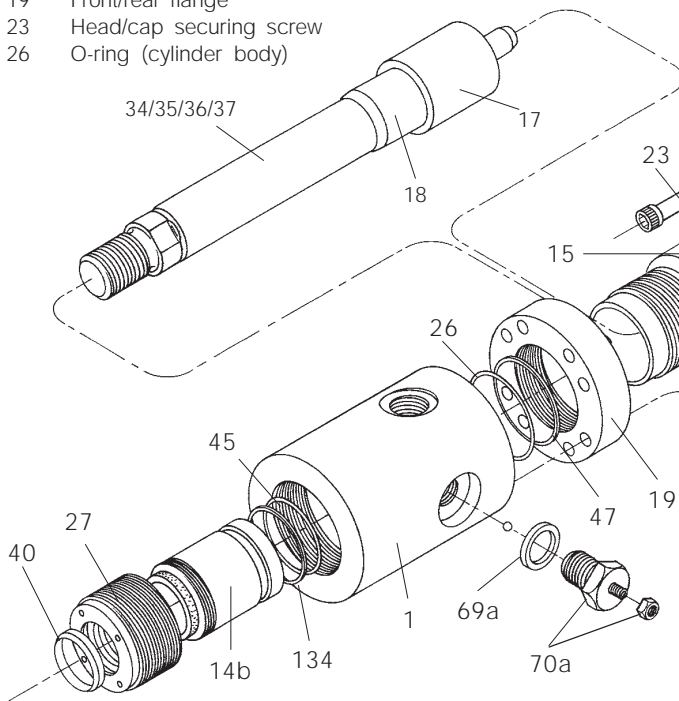

Standard Gland & Seals

Standard Piston

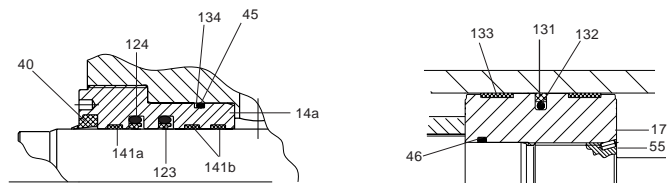

Low Friction Gland & Seals

Low Friction Piston

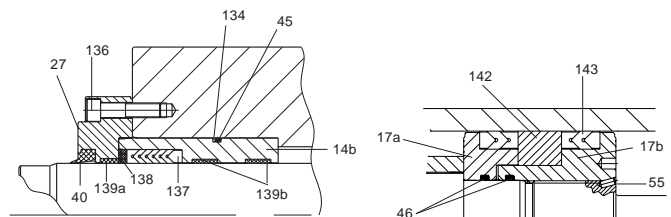

Chevron Gland & Seals

Chevron Piston

- 27 Gland retainer (secured by screws or threaded)
- 34 Piston rod – single rod, no cushion
- 35 Piston rod – single rod, cushion at head end
- 36 Piston rod – single rod, cushion at cap end
- 37 Piston rod – single rod, cushion at both ends
- 40 Gland wiperseal
- 41 Lipseal
- 45 O-ring (gland/head)
- 46 O-ring, piston/rod (2 off – chevron piston)
- 47 O-ring (cylinder body)
- 55 Piston locking pin
- 69a Cushion needle valve cartridge sealing washer
- 70a Cushion needle valve cartridge
- 73 Floating cushion bush
- 74 Cushion bush retaining ring
- 123 Stepseal

**Contents and Part Numbers of Seal Kits for
Pistons and Glands**

(see key to part numbers opposite)

RGN Kit – Standard Gland Cartridge and Seals
Contains RKN Kit plus 14a.

RGLL Kit – Chevron Gland Cartridge and Seals
Contains RKL Kit plus 14b.

RGF Kit – Low Friction Gland Cartridge and Seals
Contains RKF Kit plus 14a.

RKN Kit – Standard Gland Cartridge Seals
Contains items 40, 41, 45, 123, 124, 134, 140a and two of 140b.

RKLL Kit – Chevron Gland Cartridge Seals
Contains items 40, 45, 134, 137, 138, 139a, and two of 139b.

RKF Kit – Low Friction Gland Cartridge Seals
Contains items 40, 45, 134, 141a, and two each of 123, 124, 141b.

CB Kit – Cylinder Body End Seals and Back-up Washers
Contains two each of items 26 and 47.

PN Kit – CB Kit plus seals for Standard piston
Contains CB Kit plus 125, 126, and two of 127.

PLL Kit – CB Kit plus seals for Chevron Piston
Contains CB Kit plus 55, 142, and two each of 46 and 143.

PF Kit – CB Kit plus seals for Low Friction Piston
Contains CB Kit plus 131, 132, and two of 133.

Seal Groups Ordering

All part numbers listed contain standard, Group 1 seals. To order kits with other classes of seals, replace the last digit of the part number shown with the number of the seal group required. Eg: RGF210MMA0701, containing a Group 1 seal, becomes RGF210MMA0705 when it contains a Group 5 seal.

Service Kit Order Codes – Piston and Body

Bore Ø	CB Kit Body End Seals	PN Kit Standard Piston Seals*	PLL Kit Chevron Piston Seals	PF Kit Low Friction Piston Seals
50	CB2050MMA01	PN050MMA01	PLL050MMA01	PF2050MMA01
63	CB2063MMA01	PN063MMA01	PLL063MMA01	PF2063MMA01
80	CB2080MMA01	PN080MMA01	PLL080MMA01	PF2080MMA01
100	CB2100MMA01	PN100MMA01	PLL100MMA01	PF2100MMA01
125	CB2125MMA01	PN125MMA01	PLL125MMA01	PF2125MMA01
140	CB2140MMA01	PN140MMA01	PLL140MMA01	PF2140MMA01
160	CB2160MMA01	PN160MMA01	PLL160MMA01	PF2160MMA01
180	CB2180MMA01	PN180MMA01	PLL180MMA01	PF2180MMA01
200	CB2200MMA01	PN200MMA01	PLL200MMA01	PF2200MMA01
250	CB2250MMA01	PN250MMA01	PLL250MMA01	PF2250MMA01
320	CB2320MMA01	PN320MMA01	PLL320MMA01	PF2320MMA01

Service Kit Order Codes – Glands

Bore Ø	Rod No.	Rod Ø	RGN Kit Standard Gland Cartridge and Seals*	RGLL Kit Chevron Gland Cartridge and Seals	RGF Kit Low Friction Gland Cartridge and Seals	RKN Kit Standard Gland Cartridge Seals*	RKLL Kit Chevron Gland Cartridge Seals	RKF Kit Low Friction Gland Cartridge Seals
50	1	32	RGN05MMA0321	RGLL05MMA0321	RGF205MMA0321	RKN05MMA0321	RKLL05MMA0321	RKF205MMA0321
	2	36	RGN05MMA0361	RGLL05MMA0361	RGF205MMA0361	RKN05MMA0361	RKLL05MMA0361	RKF205MMA0361
63	1	40	RGN06MMA0401	RGLL06MMA0401	RGF206MMA0401	RKN06MMA0401	RKLL06MMA0401	RKF206MMA0401
	2	45	RGN06MMA0451	RGLL06MMA0451	RGF206MMA0451	RKN06MMA0451	RKLL06MMA0451	RKF206MMA0451
80	1	50	RGN08MMA0501	RGLL08MMA0501	RGF208MMA0501	RKN08MMA0501	RKLL08MMA0501	RKF208MMA0501
	2	56	RGN08MMA0561	RGLL08MMA0561	RGF208MMA0561	RKN08MMA0561	RKLL08MMA0561	RKF208MMA0561
100	1	63	RGN10MMA0631	RGLL10MMA0631	RGF210MMA0631	RKN10MMA0631	RKLL10MMA0631	RKF210MMA0631
	2	70	RGN10MMA0701	RGLL10MMA0701	RGF210MMA0701	RKN10MMA0701	RKLL10MMA0701	RKF210MMA0701
125	1	80	RGN12MMA0801	RGLL12MMA0801	RGF212MMA0801	RKN12MMA0801	RKLL12MMA0801	RKF212MMA0801
	2	90	RGN12MMA0901	RGLL12MMA0901	RGF212MMA0901	RKN12MMA0901	RKLL12MMA0901	RKF212MMA0901
140	1	90	RGN14MMA0901	RGLL14MMA0901	RGF214MMA0901	RKN14MMA0901	RKLL14MMA0901	RKF214MMA0901
	2	100	RGN14MMA1001	RGLL14MMA1001	RGF214MMA1001	RKN14MMA1001	RKLL14MMA1001	RKF214MMA1001
160	1	100	RGN16MMA1001	RGLL16MMA1001	RGF216MMA1001	RKN16MMA1001	RKLL16MMA1001	RKF216MMA1001
	2	110	RGN16MMA1101	RGLL16MMA1101	RGF216MMA1101	RKN16MMA1101	RKLL16MMA1101	RKF216MMA1101
180	1	110	RGN18MMA1101	RGLL18MMA1101	RGF218MMA1101	RKN18MMA1101	RKLL18MMA1101	RKF218MMA1101
	2	125	RGN18MMA1251	RGLL18MMA1251	RGF218MMA1251	RKN18MMA1251	RKLL18MMA1251	RKF218MMA1251
200	1	125	RGN20MMA1251	RGLL20MMA1251	RGF220MMA1251	RKN20MMA1251	RKLL20MMA1251	RKF220MMA1251
	2	140	RGN20MMA1401	RGLL20MMA1401	RGF220MMA1401	RKN20MMA1401	RKLL20MMA1401	RKF220MMA1401
250	1	160	RGN25MMA1601	RGLL25MMA1601	RGF225MMA1601	RKN25MMA1601	RKLL25MMA1601	RKF225MMA1601
	2	180	RGN25MMA1801	RGLL25MMA1801	RGF225MMA1801	RKN25MMA1801	RKLL25MMA1801	RKF225MMA1801
320	1	200	RGN32MMA2001	RGLL32MMA2001	RGF232MMA2001	RKN32MMA2001	RKLL32MMA2001	RKF232MMA2001
	2	220	RGN32MMA2201	RGLL32MMA2201	RGF232MMA2201	RKN32MMA2201	RKLL32MMA2201	RKF232MMA2201

* Only available with the use of Group 1 Seals

All dimensions are in millimetres unless otherwise stated.

Rod End Style 4

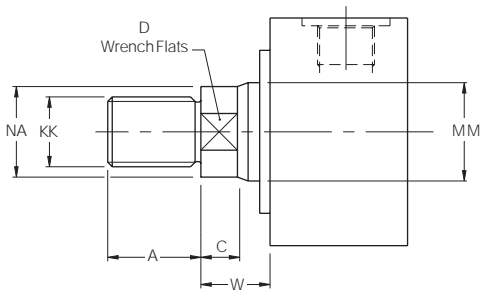

Rod End Style 9

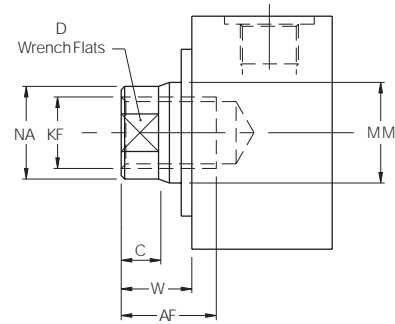

Piston Rod End Styles

MMA cylinders are available with standard metric male and female rod ends to ISO 4395. They can also be supplied with other rod end threads, eg: ISO metric coarse, Unified, British Standard etc., or to the customer's special requirements.

Style 4 denotes a standard male thread. Style 9 denotes a female thread, and is available only with the No.2 rod. Orders for non-standard rod ends, designated Style 3, should include dimensioned sketches and descriptions, showing dimensions KK or KF, A or AF, and the thread form required.

Wrench Flats

Piston rods up to and including 90mm in diameter are supplied with the wrench flats D shown in the table below. Rods above 90mm in diameter feature four drilled holes to accept a pin wrench.

Rod End Dimensions

Bore Ø	Rod No.	MM Rod Ø	A & AF	C	D	NA	KK Style 4	KF Style 9	W
50	1	32	36	15	28	31	M27 x 2	-	22
	2	36		15	32	35	M27 x 2	M27 x 2	
63	1	40	45	18	34	38	M33 x 2	-	25
	2	45		18	36	43	M33 x 2	M33 x 2	
80	1	50	56	20	43	48	M42 x 2	-	28
	2	56		20	46	54	M42 x 2	M42 x 2	
100	1	63	63	23	53	60	M48 x 2	-	32
	2	70		23	60	67	M48 x 2	M48 x 2	
125	1	80	85	27	65	77	M64 x 3	-	36.5
	2	90		27	75	87	M64 x 3	M64 x 3	
140	1	90	90	27	75	87	M72 x 3	-	36.5
	2	100		27	-	96	M72 x 3	M72 x 3	
160	1	100	95	31	-	96	M80 x 3	-	40.5
	2	110		31	-	106	M80 x 3	M80 x 3	
180	1	110	105	36	-	106	M90 x 3	-	45.5
	2	125		36	-	121	M90 x 3	M90 x 3	
200	1	125	112	36	-	121	M100 x 3	-	45.5
	2	140		36	-	136	M100 x 3	M100 x 3	
250	1	160	125	38	-	155	M125 x 4	-	50.5
	2	180		38	-	175	M125 x 4	M125 x 4	
320	1	200	160	44	-	195	M160 x 4	-	56.5
	2	220		44	-	214	M160 x 4	M160 x 4	

All dimensions are in millimetres unless otherwise stated.

How To Order

Roundline Cylinders

MMA Series

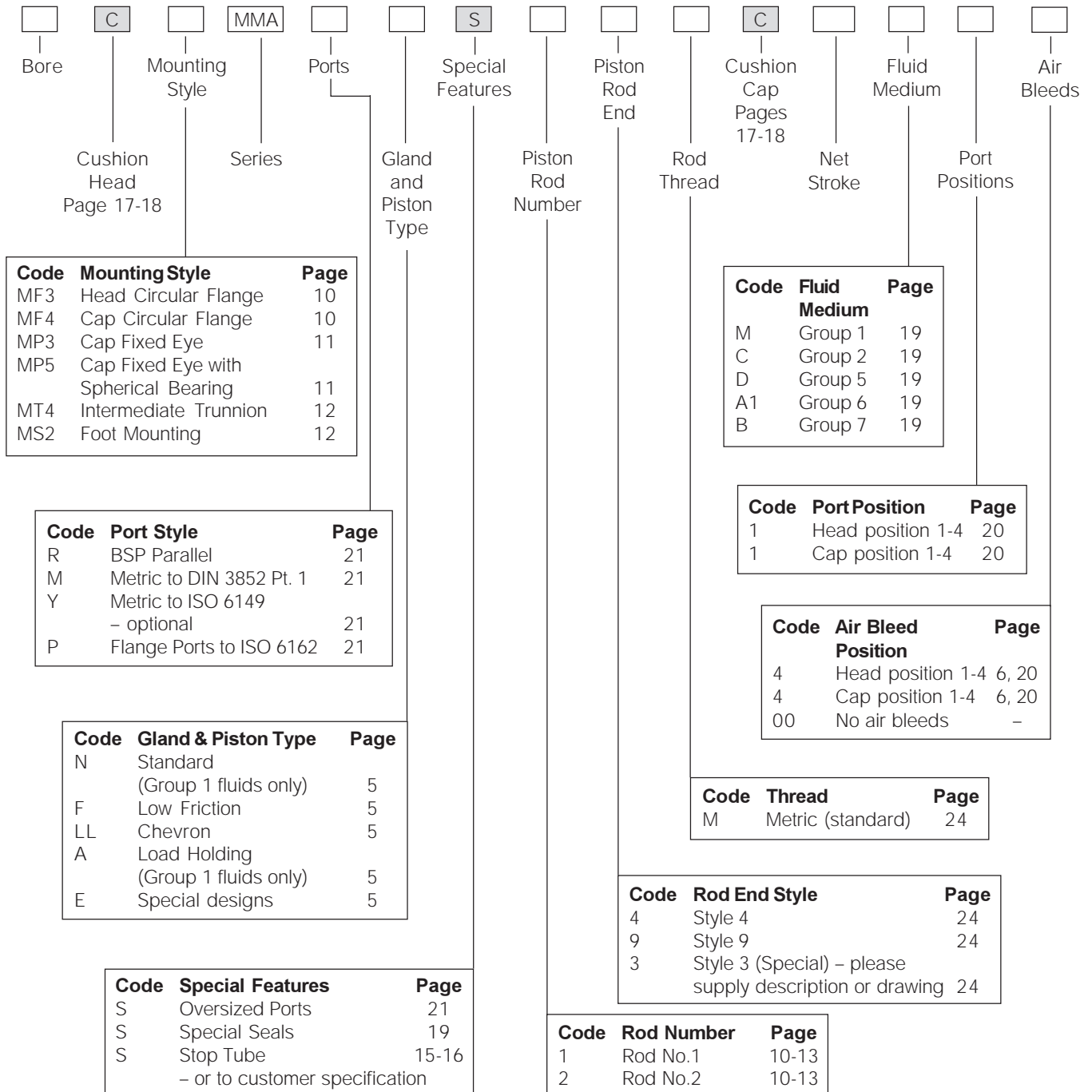

Key
 Required for basic cylinder
 Indicate optional features or leave blank

Example

50	C	MF3	MMA	R	N	S	1	9	M	C	230	M	11	44
----	---	-----	-----	---	---	---	---	---	---	---	-----	---	----	----

Accessories

Please state on order whether accessories are to be assembled to cylinder or supplied separately.



Cylinder Division Sales Offices

Austria – Marchtrenk

Parker Hannifin GmbH
Tel: (7242) 56921
Fax: (7242) 5692120

Belgium – Nivelles

Parker Hannifin S.A. N.V.
Tel: 67 280 900
Fax: 67 280 999

Czech Republic – Prague

Parker Hannifin Corporation
Tel: (02) 830 85 221
Fax: (02) 830 85 360

Denmark – Ishøj

Parker Hannifin Danmark A/S
Tel: 43 56 04 00
Fax: 43 73 31 07

Finland – Vantaa

Parker Hannifin Oy
Tel: 9 476 731
Fax: 9 476 73200

France –

Contamine-sur-Arve

Parker Hannifin S.A.
Tel: 4 50 25 80 25
Fax: 4 50 03 67 37

Germany – Cologne

Parker Hannifin GmbH
Tel: (221) 71720
Fax: (221) 7172219

Hungary – Budapest

Parker Hannifin Corp.
Tel: 1 25 28 137
Fax: 1 25 28 129

Ireland – Clonee

Parker Sales (Ireland) Ltd.
Tel: (353) 1 801 4010
Fax: (353) 1 801 4132

Italy – Arsago-Seprio

Parker Hannifin S.p.A.
Tel: (0331) 765611
Fax: (0331) 765612

Netherlands – Oldenzaal

Parker Hannifin B.V.
Tel: (0541) 585000
Fax: (0541) 585459

Norway – Ski

Parker Hannifin A/S
Tel: 64 91 10 00
Fax: 64 91 10 90

Poland – Warsaw

Parker Hannifin Corp.
Tel: (22) 863 49 42
Fax: (22) 863 49 44

Portugal –

Leca da Palmeira

Parker Hannifin Portugal Lda.
Tel: (22) 999 7360
Fax: (22) 996 1527

Slovakia –

Ref. Czech Republic

Spain – Madrid

Parker Hannifin España S.A.
Tel: (91) 675 73 00
Fax: (91) 675 77 11

Sweden – Spånga

Parker Hannifin AB
Tel: 08-5979 50 00
Fax: 08-5979 51 20

Switzerland – Romanshorn

Hydrel A.G. Romanshorn
Tel: (714) 66 66 66
Fax: (714) 66 66 80

Turkey – Istanbul

Hidroser Hidrolik - Pnömatik
Tel: (212) 886 72 70
Fax: (212) 886 69 35

United Kingdom – Watford

Parker Hannifin Plc
Tel: (01923) 492000
Fax: (01923) 248557

Visit us at www.parker.com/uk

Need a Parker part?

Call Parker's European Product Information Centre
on 00800 27 27 5374

